

● Features:

1. Chip material: AlGaInP/GaAs
2. Emitted color : Super Yellow
3. Lens Appearance : Yellow Diffused
4. Low power consumption.
5. High efficiency.
6. Versatile mounting on P.C. Board or panel.
7. Low current requirement.
8. 3mm diameter package.
9. This product don't contained restriction substance, compliance RoHS standard.

● Applications:

1. TV set
2. Monitor
3. Telephone
4. Computer
5. Circuit board

● Package dimensions

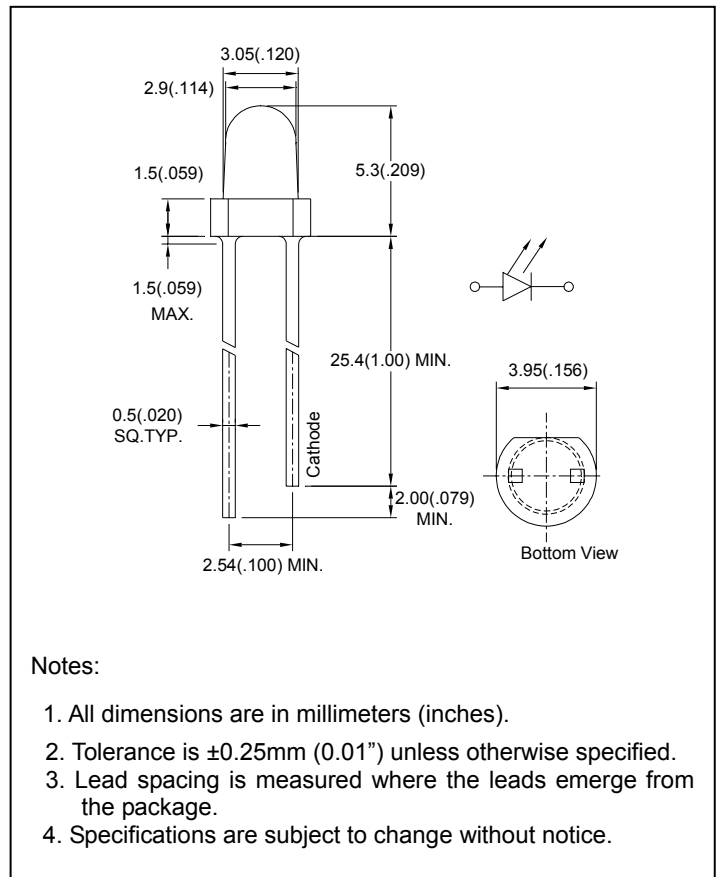

● Absolute maximum ratings(Ta=25°C)

Parameter	Symbol	Rating	Unit
Power Dissipation	Pd	80	mW
Forward Current	I _F	30	mA
Peak Forward Current*1	I _{FP}	150	mA
Reverse Voltage	V _R	5	V
Operating Temperature	Topr	-40°C~85°C	
Storage Temperature	Tstg	-40°C~100°C	
Soldering Temperature	Tsol	260°C max (for 5 seconds)	
Hand Soldering Temperature	Tsol	350°C max(for 3 seconds)	

*1 Condition for I_{FP} is pulse of 1/10 duty and 0.1msec width.

● Electrical and optical characteristics(Ta=25°C)

Parameter	Symbol	Condition	Min.	Typ.	Max.	Unit
Forward Voltage	V_F	$I_F=20\text{mA}$	-	2.1	2.6	V
Luminous Intensity	I_v	$I_F=20\text{mA}$	-	1000	-	mcd
Reverse Current	I_R	$V_R=5\text{V}$	-	-	100	μA
Peak Wave Length	λ_p	$I_F=20\text{mA}$	-	590	-	nm
Dominant Wave Length	λ_d	$I_F=20\text{mA}$	580	-	592	nm
Spectral Line Half-width	$\Delta\lambda$	$I_F=20\text{mA}$	-	15	-	nm
Viewing Angle	$2\theta_{1/2}$	$I_F=20\text{mA}$	-	45	-	deg

● Typical electro-optical characteristics curves

Fig.1 Relative intensity vs. Wavelength

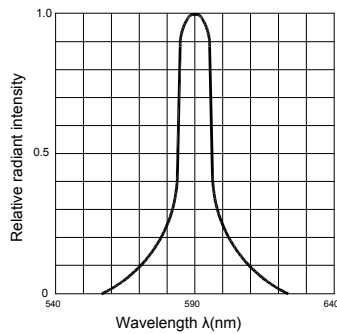

Fig.2 Forward current derating curve vs. Ambient temperature

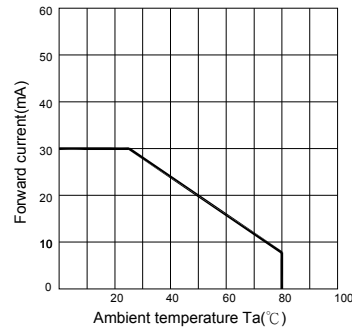

Fig.3 Forward current vs. Forward voltage

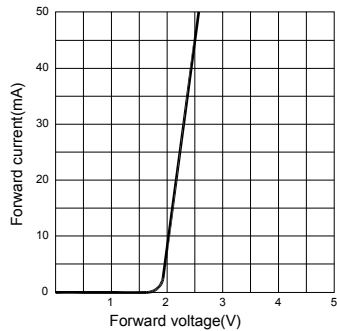

Fig.4 Relative luminous intensity vs. Ambient temperature

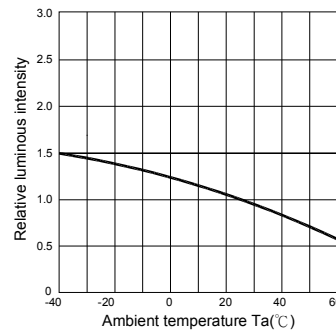

Fig.5 Relative luminous intensity vs. Forward current

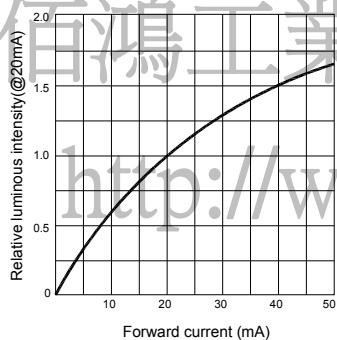
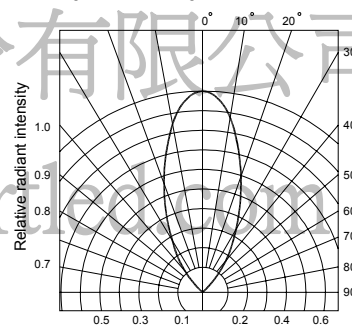

Fig.6 Radiation diagram



● DIP soldering (Wave Soldering)

Preheating : 120°C, within 120~180 sec.

Operation heating : 255°C±5°C within 5 sec. 260°C (Max)

Gradual Cooling (Avoid quenching).

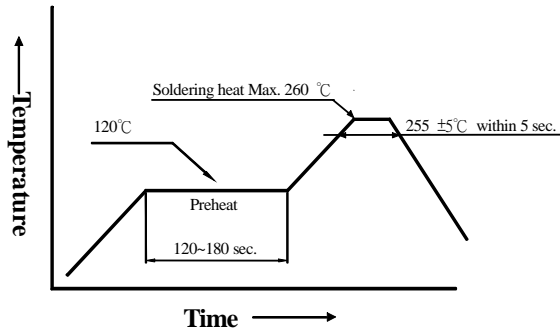

佰鴻工業股份有限公司

<http://www.brtled.com>